

METALMASTER

UNDERDRIVEN GUILLOTINE OPERATION MANUAL



Models
HG-440B, HG-460B,
HG-840B, HG-860B, HG-1060B

Edition No : UDG-01

Date of Issue : 08/07/2016

www.machineryhouse.com.au



OPERATION MANUAL

MACHINE DETAILS

MACHINE	HYDRAULIC GUILLOTINE
MODEL NO.	
SERIAL NO.	
DATE OF MANF.	

Distributed by



www.machineryhouse.com.au

www.machineryhouse.co.nz

Note:

This manual is only for your reference. Owing to the continuous improvement of the machine, changes may be made at any time without obligation or notice. Please ensure the local voltage is the same as listed on the specification plate before operating this electric machine.



NOTE:

In order to see the type and model of the machine, please see the specification plate. Usually found on the back of the machine. See example (Fig.1)

METALMASTER	
PRODUCT SPECIFICATION	
MODEL:	
CAPACITY:	
SER. NO:	
MFG DATE:	
WEIGHT:	
VOLTS:	
MOTOR Kw:	
<small>www.machineryhouse.com.au Made in China</small>	

Fig.1



OPERATION MANUAL

CONTENTS:

1. GENERAL MACHINE INFORMATION

1.1 Specifications.....	4
1.2 Standard Equipment.....	4
1.3 Overall Drawings.....	5

2. IMPORTANT INFORMATION

2.1 Safety Requirements.....	7
2.2 Safety Features of the Machine.....	9
2.3 Lifting Instructions.....	11

3. INSTALLATION

3.1 Base Foundation and Securing Points.....	12
3.2 Machine Leveling.....	13
3.3 Checking the Power Supply.....	13
3.4 Attaching The Accessories.....	14
3.5 Fill The Hydraulic Oil Tank.....	15

4. COMMISSIONING

4.1 Preparation of the Machine.....	16
4.2 Omrom E3z Safety Sensor Alignment.....	16
4.3 Calibrate "X" Axis On Controller.....	19
4.4 Commissioning Check List.....	19

5. OPERATION INSTRUCTION

5.1 Pre-Operational Safety Check Prior to Operating.	20
5.2 NC89 Controller Operation.....	21
5.3 Setting The Blade Gap.....	22

6. MAINTAINANCE

6.1 Type and frequency of Inspections.....	23
6.2 Lubrication Points.....	24
6.3 Changing Oil.....	25
6.4 Changing The Filter.....	26
6.5 Adjusting The Top Beam Slides.....	27
6.6 Adjusting Blade Clearance & Parallelism.....	27
6.7 Troubleshooting.....	29
6.8 Storage, & Re-Utilization.....	30

APPENDIX

A. Hydraulic Circuit Diagram.....	31
B. Electrical Circuit Diagram.....	32
Risk Assessment Sheets.....	34



OPERATION MANUAL

1.1 SPECIFICATIONS:

Machine Type	HG-440B	HG-460B	HG-840B	HG-860B	HG-1060B
Shearing Length (mm)	1300	1300	2500	2500	3100
Material Capacity Mild Steel (mm)	4	6	4	6	6
Material Capacity Stainless Steel (mm)	2	4	2	4	4
Shear Angle (degree)	2	2	2	2	2
Back Gauge Range (mm)	700	700	700	700	700
System Pressure	16	16	16	16	16
Oil Tank Volume	60	60	80	80	80
Dimensions Width (mm)	2010	2010	3170	3170	3773
Depth (mm)	900	900	900	1065	1120
Height (mm)	1375	1375	1375	1490	1490
Weight (kgs)	2120	2380	2734	3315	4430
Main Motor 3 Phase 415 Volt 50Hz (kW)	5.5	5.5	5.5	7.5	7.5
Back Gauge 3 Phase 415 Volt 50 Hz (kW)	0.55	0.55	0.55	0.55	0.55

1.2. STANDARD EQUIPMENT:

Electric motor: 415V 3phase
 Back-gauge assembly
 Front guarding
 Oil tank level indicator
 Footswitch and control panel



OPERATION MANUAL

1.3 OVERALL DRAWINGS AND FOUNDATIONS

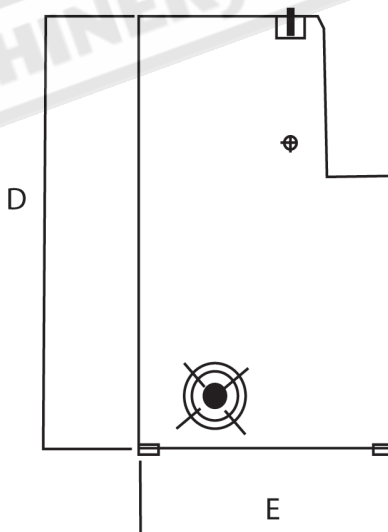
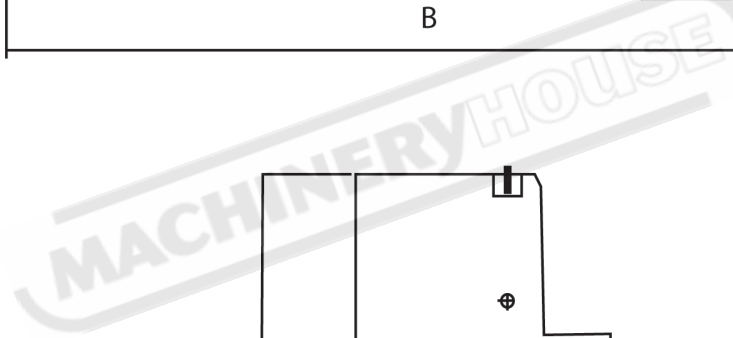
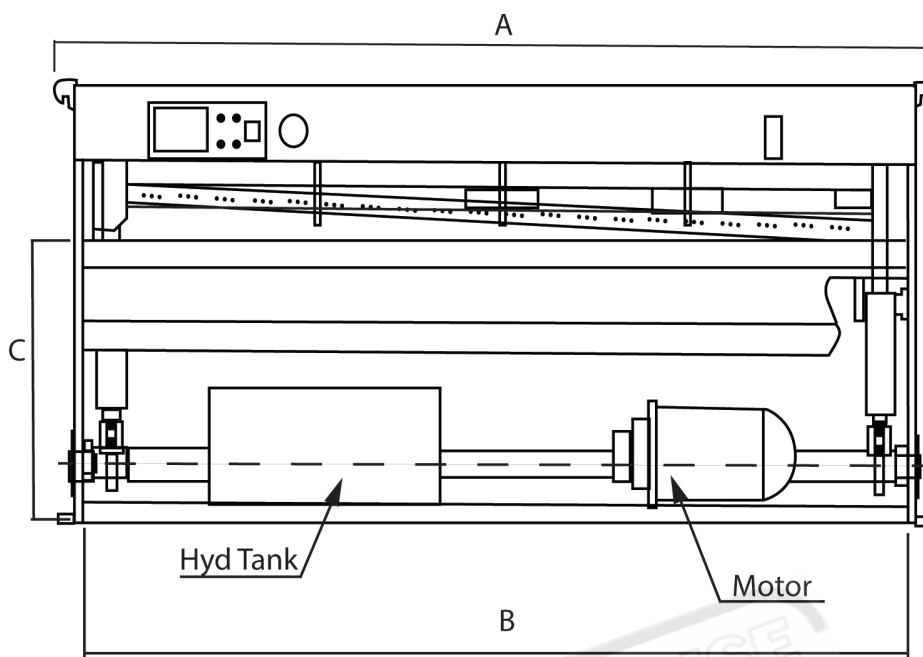

mm	HG-440B	HG-460B	HG-840B	HG-860B	HG-1060B
A	1970	1970	3081	3081	3659
B	1695	1695	2895	2895	3475
C	835	835	835	835	835
D	1320	1320	1320	1320	1449
E	900	900	900	900	1050



OPERATION MANUAL

Back Gauge

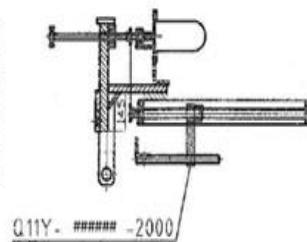
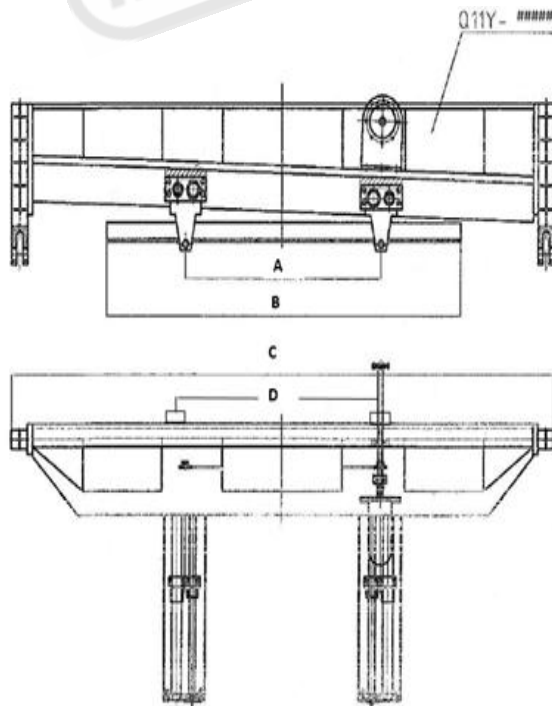
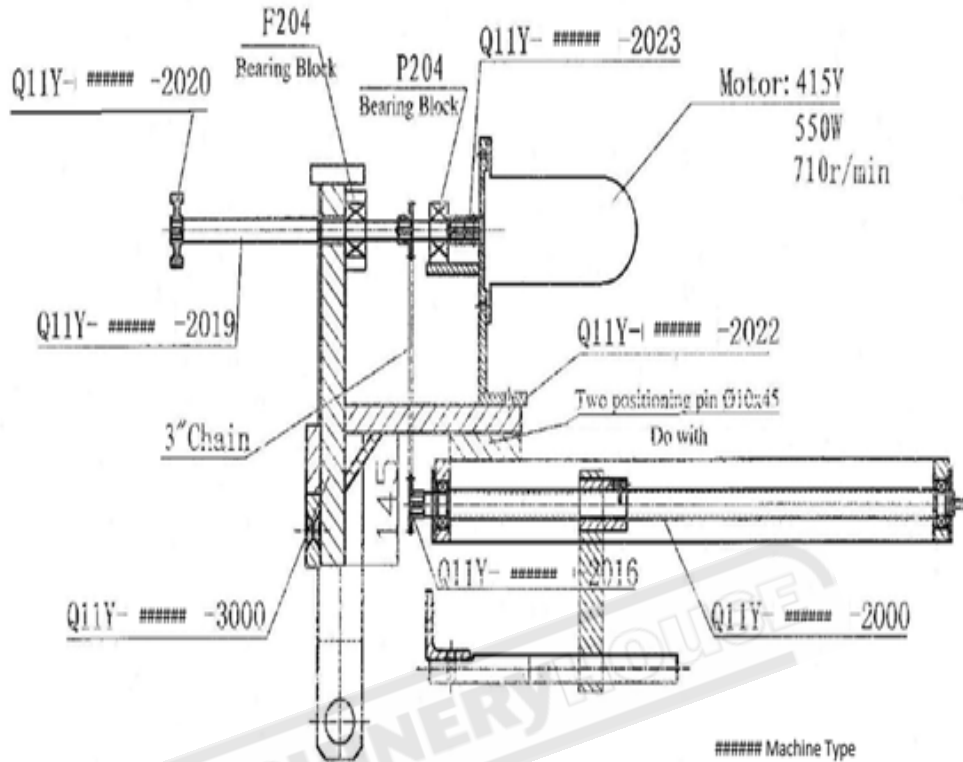

	HG-440B	HG-840B	HG-860B	HG-1060B
A	900	1500	1000	1500
B	500	1100	1800	2380
C	1560	2760	2760	3340
D	620	1430	930	1430



OPERATION MANUAL

2.1 SAFETY REQUIREMENTS

DO NOT use this machine unless a Qualified person has instructed you in its safe use and operation of the machine.

The most common metal guillotine injuries are crushed or amputated fingers.

Most of these accidents are not caused by the blade of the guillotine, but by the clamps that hold the sheet metal being cut. Other injuries are from fingers jamming under the sheet that is to be cut, and strain injuries while handling large and awkward sheets of metal.

By law, guillotines must be guarded, and operators must be trained. Safe working procedures must be developed to prevent injuries.



Safety glasses must be worn at all times in work areas. Earmuffs should be worn if the work area is noisy.



Sturdy footwear must be worn at all times in work areas.



Gloves should be worn when handling the material used on this machine.



Long and loose hair must be contained with a net or under a hat

The following topics can be used as a guide to identify workplace hazards and to reduce the risks of metal guillotines.

It is an unsafe practice for two people to work at a guillotine unless both operators are provided with interlocked actuating devices (usually a foot control). However in some guillotine operations, for example cutting large sheets, two operators may be required to maneuver sheets into position before cutting. For such operations safe work procedures should be developed to control any hazards.





OPERATION MANUAL

SAFETY CHECKS BEFORE OPERATING

- Ensure fixed guards are in place to prevent hands or other parts of the body from entering the trapping space.
- Guards or safety devices must never be removed or adjusted, except by an authorized person for maintenance purposes.
- Working parts should be well lubricated and free of rust and dirt.
- The area around the machine must be adequately lit and kept free of materials, which might cause slips or trips.
- Be aware of other personnel in the immediate vicinity and ensure the area is clear before using equipment.
- Familiarize yourself with and check all machine operations and controls.
- Ensure cutting table is clear of scrap and tools.
- Faulty equipment must not be used. Immediately report suspect machinery

SAFETY CHECKS WHEN OPERATING

- Do not attempt to cut material beyond the capacity of the machine.
- Never attempt to cut rod, strap or wire with this machine.
- Use correct lifting procedures when handling large sheets of material.
- Take extreme care during the initial feeding of the workpiece into the machine.
- The workpiece should always be held sufficiently far back from the edge being fed into the guillotine.
- Ensure fingers and limbs are clear before actuating the guillotine.
- Hold material firmly to prevent inaccurate cutting due to creep.
- When cutting ensure feet are positioned to avoid contact with the foot operated lever.

SAFETY CHECKS AFTER OPERATION

- Remove all off cuts and place them in either in the storage rack or waste bin.
- Leave the work area in a safe, clean and tidy state.

POTENTIAL HAZARDS

- Cuts from the sharp edges and burrs on the sheets before and after cutting
- Parts of the body being caught in crush and pinch points.
- Injuries caused when handling metal sheets



OPERATION MANUAL

2.2. SAFETY FEATURES OF THE MACHINE:

The electrical and hydraulic circuits of your machine are designed to allow operation with maximum safety. The following precautions are available on the machine for enhanced safety.

Emergency stop buttons (engaging type) are available on the foot switch control unit. Once the button has been pressed to reset the emergency stop, the red button must be rotated to reset the stop.

Foot pedal control

The foot pedal when pressed activates the shearing beam and must be held in the depressed position until the machine has completed its cut. Releasing the foot pedal during the shearing operation will return the machine to the top of its stroke

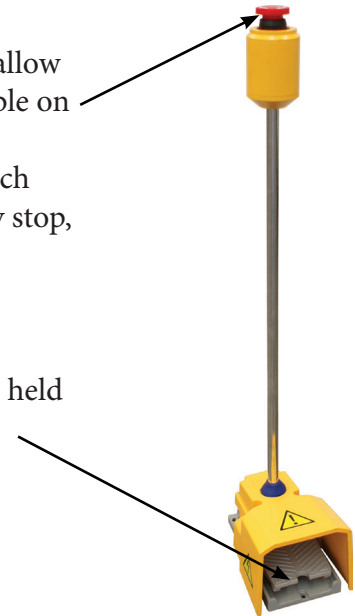

Main Controls

The main machine operating controls are located on the pendant.



1	Continuous or Single Cut	5	Power On Indicator Light
2	Rear Guard Sensor Light	6	Hydraulic Pump On Indicator Light
3	Shadow Line Light ON/OFF	7	Hydraulic Pump Stop
4	Power ON/OFF to Controller	8	Emergency Stop

METALMASTER

OPERATION MANUAL

To prevent operator or other persons from accidental injury the machine operation includes a photoelectric light guard at the back of the machine

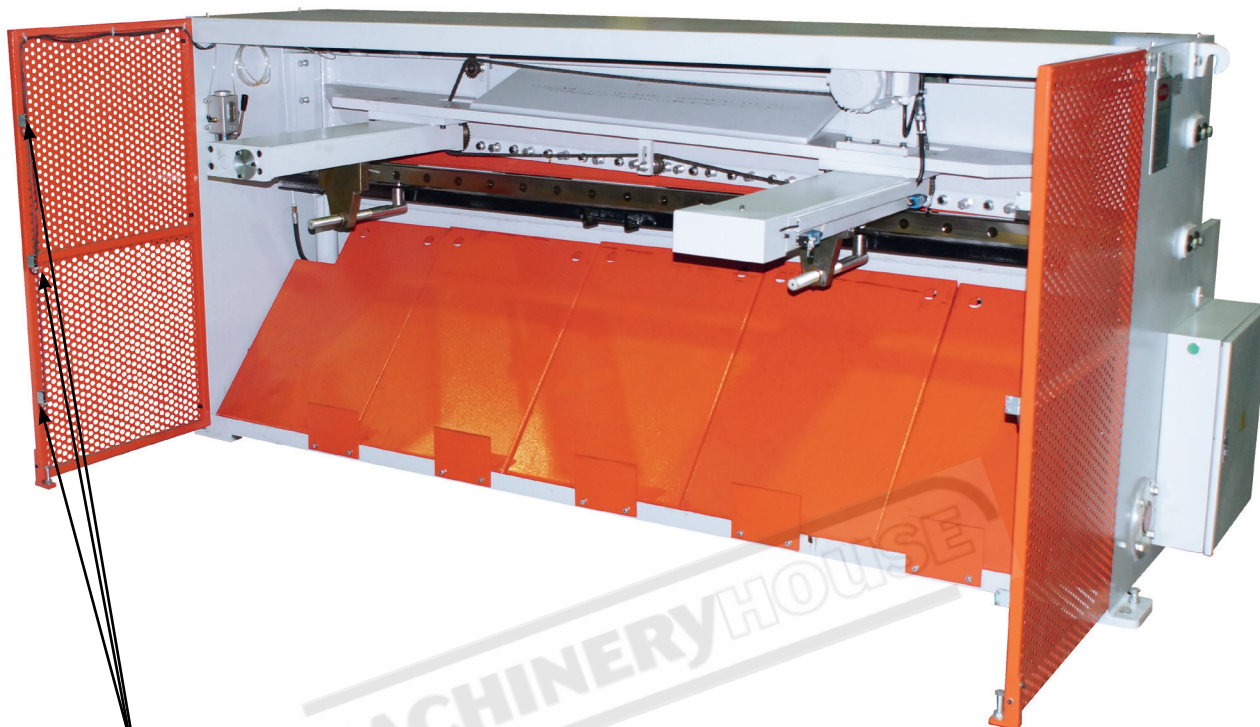

3 x Photoelectric safety cells are placed on both sides of the back of the machine. When the beam is broken the machine stops.

Once the beam has been broken the system needs to be reset. This is done by pressing the reset button on the electrical cabinet.





OPERATION MANUAL

2.3 LIFTING INSTRUCTIONS

On the day that the machine arrives, make sure that a crane with sufficient capacity is available to unload the machine from the vehicle. Ensure access to the chosen site is clear and that doors and ceilings are sufficiently high and wide enough to receive the machine.

To handle the Guillotine, use only the two sling lifting points located on the top of the end plates. (Fig. 2.3) The slings should be positioned so the machine is level when lifted.

When using slings please take note of the sling angle and the loads that apply

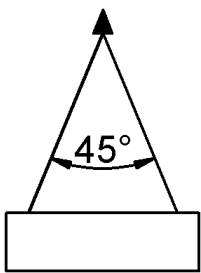

Fig 2.1.

When the slings are at a 45° angle then each sling is carrying the equivalent of 50% of load weight. (Fig.2.1).

When the slings are at a 90° angle then each sling will have a weight equal to 75% of the load on each sling. (Fig 2.2)

Note! Metalmaster recommend not to exceed 90° angle

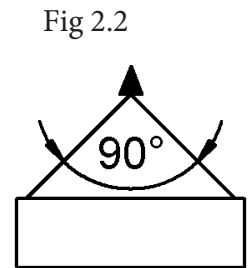

Fig 2.2

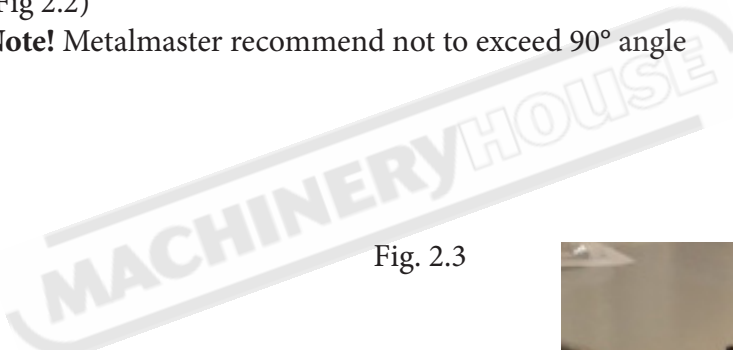

Fig. 2.3

Lifting Points

When lifting the machine only certified lifting slings should be used.

Ensure that when lifting, the machine does not tip over.

Check that the lifting slings do not interfere with the hydraulic pipes or electrical conduits.

Failure to follow these instructions could cause damage to the machine



3. INSTALLATION

The machine is delivered in complete assembled execution. It must be leveled and firmly stationed on the floor where it is to be used, according to the Installation Diagram attached. Indoor installation and a dry working environment without danger of fire and explosion is necessary.

The floor load, where the machine is to be installed, must be suitable for the weight of the machine.

3.1 BASE FOUNDATION AND SECURING POINTS

Before securing the machine a solid concrete base must be prepared to the specification of the machine. (Fig.3.1)

The sizes for the bolt holes position are listed as A-B and should be level to 0.2/1000. A:B sizes need to be checked with the distributor or measured on the machine.

Fig. 3.1

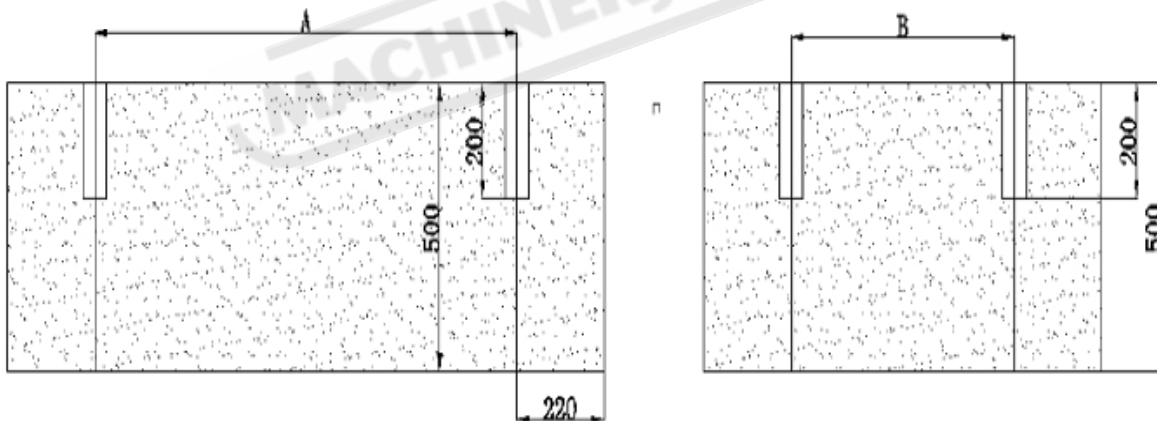



OPERATION MANUAL

3.2 MACHINE LEVELING

To set your machine up so that it operates to optimum performance, apply the following procedure After your guillotine has been anchored to a concrete slab floor, it then needs to be leveled. The leveling is performed using each of the screws on each pad.(Fig. 3.1). Loosen the hold down bolts and place a level on the surface of the working table. Tolerances: 1000:0.30mm, for both longitudinal and transverse.

Metal plates need to be placed under each jacking screw to distribute the load. Once level then tighten the hold down bolts.

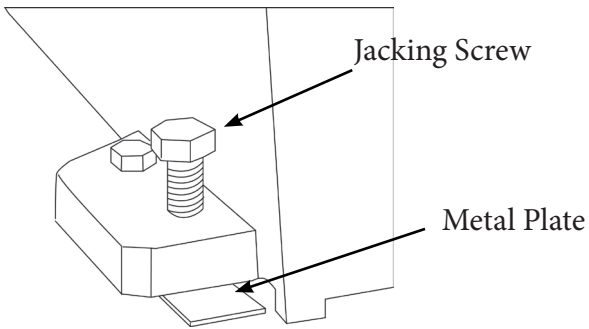

The machine must not rest on supports other than those defined in Fig. 3.2

Fig. 3.2

3.3 CHECKING THE POWER SUPPLY

METALMASTER machines are supplied wired ready to run. Check the specification plate on the machine to confirm the correct voltage of the power supply.

The machine must be connected to the power by a qualified and licensed electrician. Warranty may be voided if it is found that the connection was not carried out by a qualified electrician.



METALMASTER

OPERATION MANUAL

3.4 ATTACHING THE ACCESSORIES.

- Bolt the support arms onto the feed table. Ensure they are level and square to the table. (Fig 3.4)

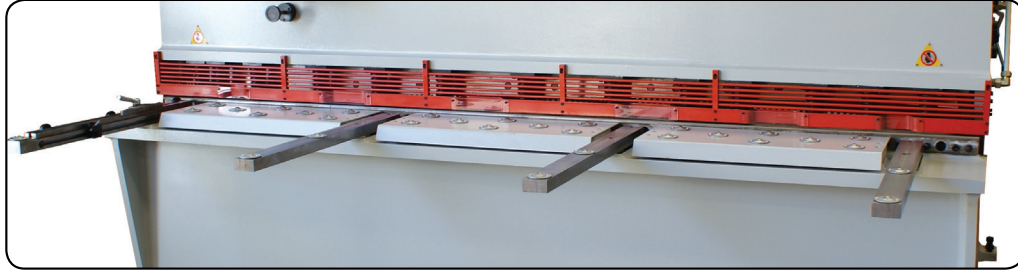

Fig. 3.4

- Place the squaring stops Fig 3.5 into position on the table top, securing into place with the bolts supplied. Check that the square stops are square to the blade. Adjust by loosening the bolts and moving by the amount allowed by the clearance of the holes.
- Re tighten the screws.



Fig. 3.5

- Unpack and attach the rear fence to the back of the machine. Ensure that the sensors have been connected and set up. (Fig.3.6)
- Unpack the mobile foot control and plug the into the socket provided on the machine. (Fig.3.7)

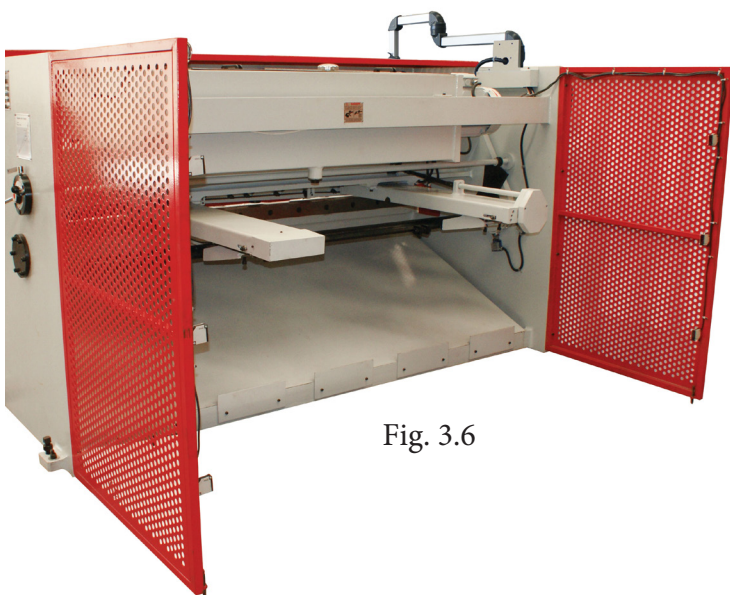

Fig. 3.6



Fig. 3.7



OPERATION MANUAL

3.5 FILL THE HYDRAULIC OIL TANK.

When filling the tank with oil, make sure that the top of the tank is clean and free from dust and dirt.

- Remove the screws from the oil tank cover and remove the cover (Fig 3.8)
- Using a pump or proper equipment to add the oil into the tank
- Oil level must be filled to the top mark of the oil indicator.
- Always keep the oil at the same level.

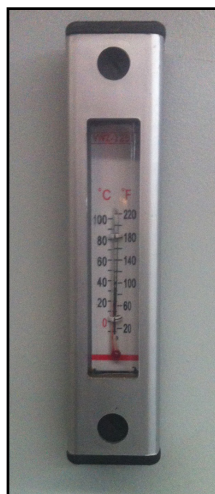
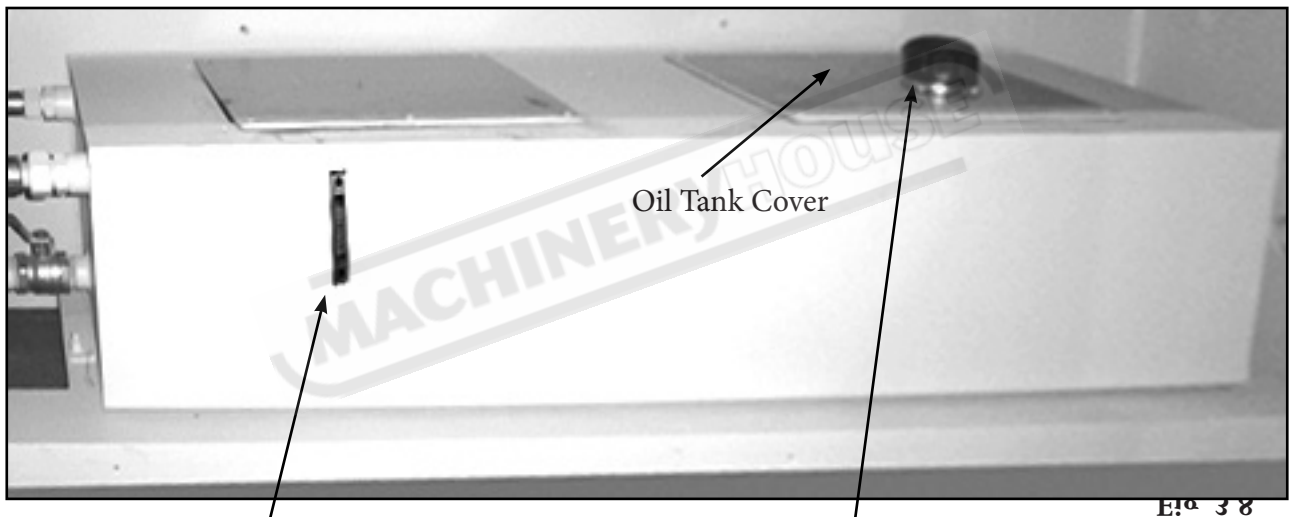

Sight Glass



Filler Cap



OPERATION MANUAL

4. COMMISSIONING

4.1. PREPARATION OF THE MACHINE.

- Remove all wrapping and packing grease from the machine.
- Check the machine for loose bolts. Tighten as required.
- Ensure that the neon light bulbs and holders are in place and have not been damaged during transit.
- Inspect for oil leakage or loose fittings. Similarly check the main rams between the top frames.
- Clean the blades and tighten the securing bolts as required. Examine the cutting edges of both blades for damage.
- Inform your service provider of any damage or faults with the machine.

4.2 OMROM E3Z SAFETY SENSOR ALIGNMENT

Warning- Follow all setup instructions before starting hydraulic pump.

The safety circuit consists of a reset switch and two rear side guards, each having 3 sensors. Your machine may or may not have a RED warning light. If there is no red warning light, then see the NC89 for display (Reset Rear Guard). When the main power is switched on or the rear sensors have been tripped the safety circuit must be reset before the hydraulic pump can be started.

Warning Indication: The safety circuit has not been Reset.

Red Warning Light



NC89 Display



or

Reset Switch

Press to reset safety circuit and then press OK on NC89.

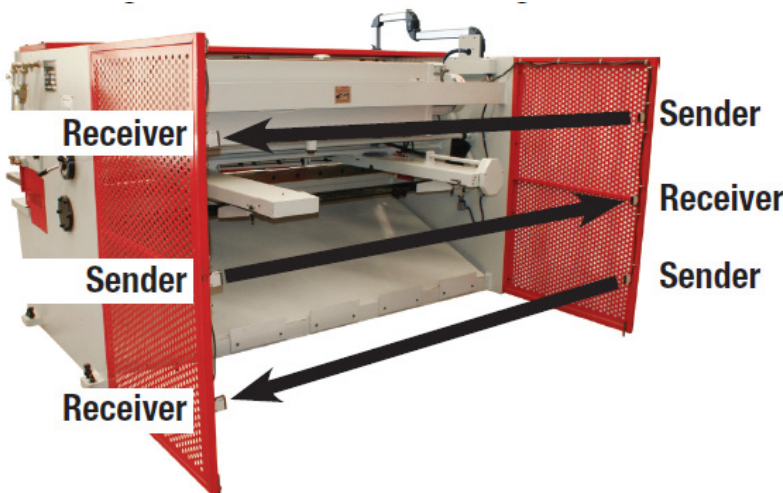
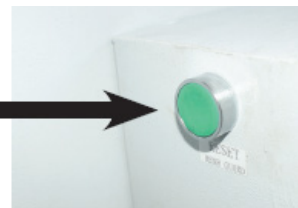



OPERATION MANUAL

4.2 OMROM E3Z SAFETY SENSOR ALIGNMENT. CONT.

Identifying Sensors

Sender

The sender has one red light on top of the unit and one red light at the front. These two lights will be on all the time while the machine has power.



Receiver

The receiver has two lights on top of the unit. The receiver should have one green light on or a red and green light on when all the sensors have been aligned correctly.



**Receiver - No lights on.
Indicates no power supply.**



**Receiver - Green light on.
Indicates power is on but
not aligned.**



**Receiver - Red & Green
lights on. Indicates power is
on & aligned.**

Note: No.1 receiver could be mounted top, middle or bottom on the guard.

The receivers are wired in series so No.1 receiver will have a green light on, indicating it has power. When it is correctly aligned with its sender the red & green light will be on and it will send power to No.2 receiver.

No.2 receiver will have a green light on and when that receiver has been correctly aligned with its sender the red & green light will be on and it will send power to the No.3 receiver.

No.3 receiver is aligned using the same technique.

So when all 3 receivers are aligned correctly with their corresponding senders they should all have red and green lights on top of each unit.

Identifying Sensors



OPERATION MANUAL

4.2 OMROM E3Z SAFETY SENSOR ALIGNMENT. CONT.

Alignment of Senders & Receivers

Ensure that the machine is level and all four leveling jacking bolts are correctly adjusted. Check the rear guards are bolted tight and adjust the stabilizing feet to ground level to support the guards. The sensors are sensitive to alignment so try to align as accurately as possible. If the sender is only just aligned with the receiver, any vibration when cutting will stop the pump and the safety circuit will have to be reset again.

Loosen the sender screws and angle sender up until receiver loses alignment.

Angle sender down until receiver re-aligns and then loses alignment again.

Half way between these two positions is the most accurate alignment.

The sensors may also have to be angled sideways as well to get the best possible alignment. This may involve packing individual brackets or sensors.

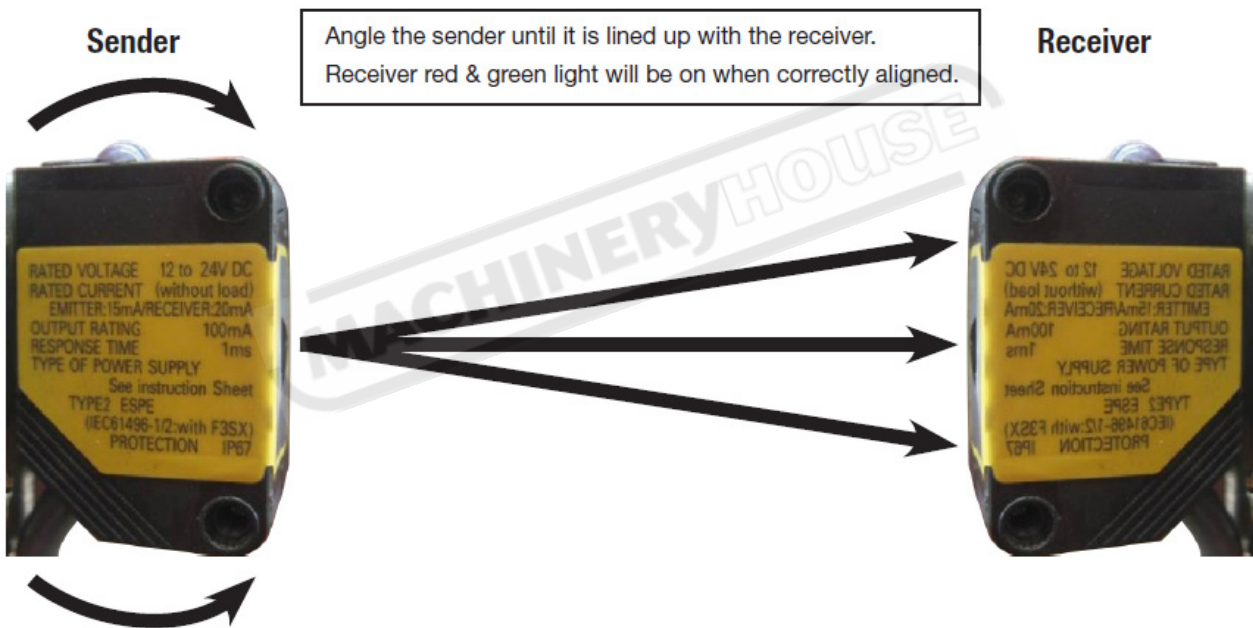

You can now reset the safety circuit & press OK on the NC89.

After a successful reset the NC89 screen should be the same as Fig. 1

The Pump can now be started



Fig. 1



OPERATION MANUAL

4.3 CALIBRATE "X" AXIS ON CONTROLLER

Before operating the machine the "X" axis needs to be checked. The following is that process.

- 1 Cut a piece of material and measure it with a vernier. Check the dimension against the x position on the readout. If the measurement is the same then the "X" axis has been set. If they are different then do the following.
- 2 With power off hold finger on red button on the controller and turn on power key.
- 3 Arrow down to test and press ok
- 4 Arrow down to set position and press ok. The controller will ask you to enter the access code below..

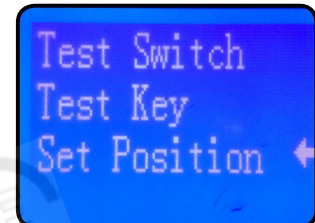
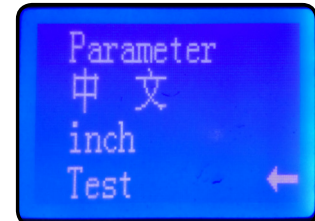
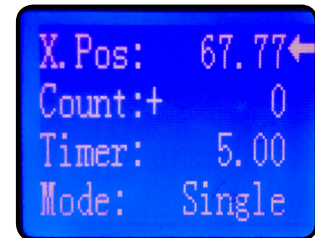

ACCESS CODE IS 258

- 5 After entering the access code delete size on screen and enter new size
- 6 Press ok to save changes
- 7 Press ESC 3 times to exit out to normal screen.

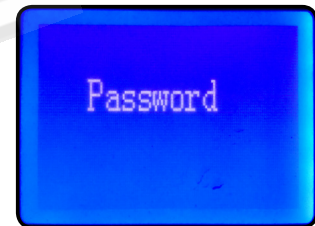
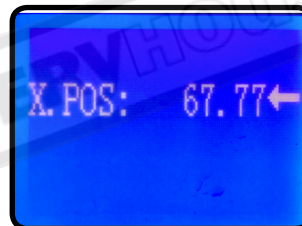

4.4. COMMISSIONING CHECK LIST.

Before starting the machine the following checks must be carried out.

- Installation and machine preparation has been performed according to the manuals instructions.
- Fill the oil reservoir with 46 grade hydraulic oil and ensure that the oil filter breather cap is fitted
- All grease nipple points have been lubricated.
- Electrical earth fitted and power circuits, switches, and foot-pedal checked.
- Check power connections and any damage to any wiring.
- Setup rear sensors
- Check pump rotation.
- Test safety operation, Estop, rear sensors, stop button etc.
- Test controller operation.
- Test all mechanical operation on the machine including blade and back gauge travel and limit switch operation.
- Calibrate x axis on controller.
- Test cut material and check quality of cut
- Tools, equipment and personnel are clear of the machine.
- Operation Manual on how to operate the machine has been read.



OPERATION MANUAL

5. OPERATION INSTRUCTIONS

5.1 PRE-OPERATIONAL SAFETY CHECK PRIOR TO OPERATING

Before operating the machine the rear safety beam guard needs to be checked. Below are the steps that need to be followed.

1. Start machine as per instruction procedures
2. Stand outside rear safety gate & obstruct sensor (1)
3. Ensure machine has stopped and is disabled
4. Check your control: Warning light (A) Warning message (B)
5. Press green reset button rear of electrical box refer image (D)
6. Press OK on NC-89 control panel to activate guard system (B)
7. Repeat steps 1 to 6 for each sensor (2) & (3)

A: Basic Control - Light on



B: NC-89 Control Display



C: Rear Guarding Sensors



D: Guard Reset Button



Emergency Stop Check,

1. Start machine as per instruction procedures
2. Press emergency stop button on control panel
3. Ensure machine has stopped and is disabled
4. Reset emergency stop button by twisting red dial (Some models need guard to also be reset) (D)
5. Repeat steps 1 to 4 for each emergency stop on your machine

E: Rear Guarding Sensors





D: Guard Reset Button



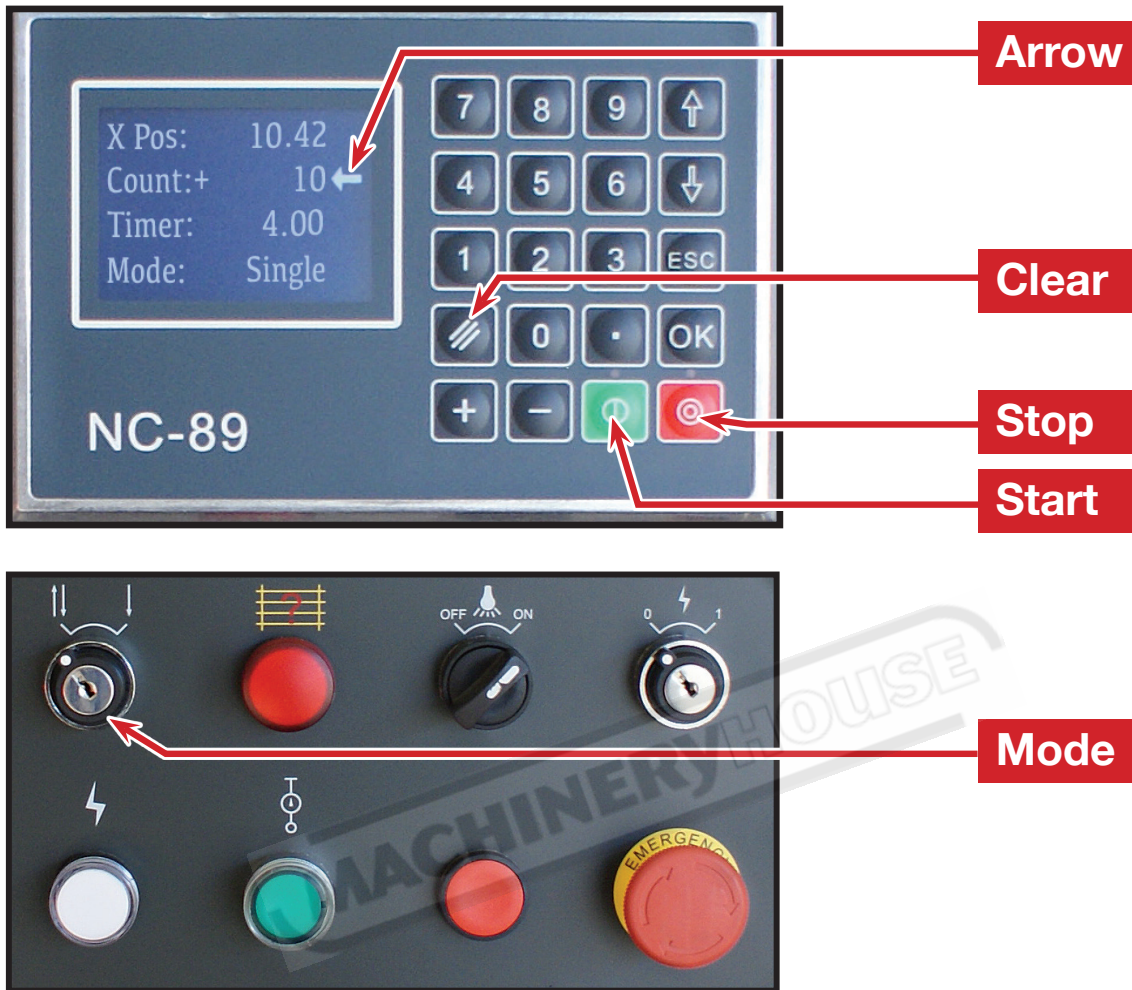



5.2 NC89 CONTROLLER OPERATION





X. Pos: *Back gauge position.*

Operation: Move Arrow to X Pos, clear number , enter desired value, press  and  start button. The back gauge will now go to the new entered position to within 0.5mm. Once back gauge has stopped searching use the manual handle for fine adjustment.

Count: *Number of cuts.*

Count can be cleared at any time by using clear  button, it will then count upwards with each cut. A set number of cut can also be entered. **Operation:** Move Arrow to Count, clear the number , enter eg. 3 and press . After 3 cuts it will count down to 0 and the controller will stop cutting. You must now arrow down to Count and press  for counting upwards or enter any number for counting downwards.

Timer: *Length of cut.*

The length of cut can be changed to suit the width of material being cut. **Operation:** Arrow down to timer, clear value and enter new value for cut length time, press  and  start button.

Mode: *Cont / Single*

Mode Single - Used to perform 1 cut at a time when foot pedal is pressed.

Mode Cont - Used to perform continuous cutting when foot pedal is pressed.



OPERATION MANUAL

5.3 SETTING THE BLADE GAP

Check the maximum cutting capacity of the guillotine.. This can be found on the specification plate on the machine. The capacity listed is for Mild Steel. Stainless steel capacity can be found in the specification table in this manual. (Page 3)

Check The Blade Gap Setting

The machine is supplied from the factory with the blade gap set to the capacity of the machine.

Where there are long part runs of the same thickness, the blade gap should be set to that thickness.

The blade gap should be approximately 10% of the thickness of the material.

- E.G. 1mm material = 0.1mm Blade Gap
- 2mm material = 0.2mm Blade Gap

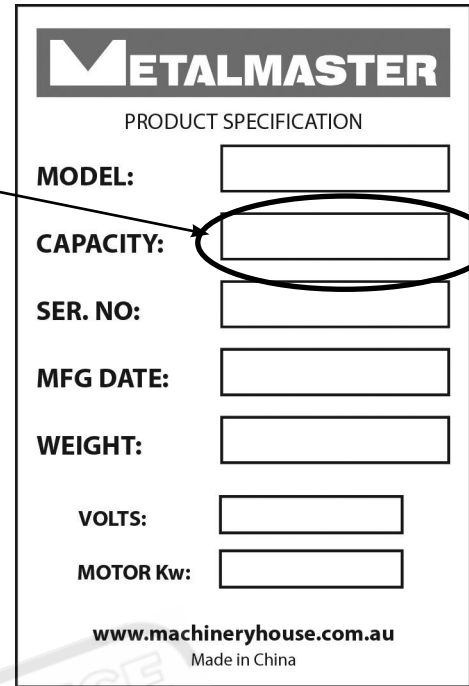

Adjusting the Blade Gap

Step 1. Isolate the machine from the power supply and place a maintenance tag on the electrical cabinet.

Step 2. Loosen the 4 head bolts at both ends of the machine. Be sure they are loose enough to allow the head to move. (Fig.5.3)



Fig. 5.3

Step 3. Set the rapid blade adjustment to the correct gap. Repeat the operation at the opposite end of the machine to ensure that the blade is parallel. (Fig. 5.4) If the blade is not parallel see section 5.3

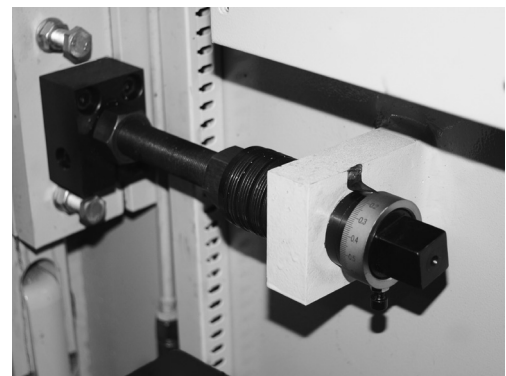

Fig. 5.4

Step 4. Re-tighten the head bolts at both ends of the machine. Do not over tighten the bolts as this can reduce the set blade gap



OPERATION MANUAL

6. MAINTENANCE

6.1 TYPE AND FREQUENCY OF INSPECTIONS

Inspection	Period	Responsibility
Lubrication of all grease points	Daily	Operator
Lubrication of slideways	Weekly	Operator
All Guards that protect against physical damage	Daily	Operator
Machine fixing bolts against loosening	Weekly	Operator
Oil leakage in cylinders	Weekly	Operator
Hydraulic Oil Change and filter	1000hrs	Maintenance
Oil leakage in pipes, hoses and hydraulic elements	Weekly	Operator
Hydraulic fluid level	Weekly	Operator
Cylinder connections bolts against loosening	Weekly	Operator
Safety & limit switches against loosening, damage	Weekly	Operator
Terminal connections of the electrical installation	Annually	Electrician

Fig. 6.1



OPERATION MANUAL

6.2 LUBRICATION POINTS

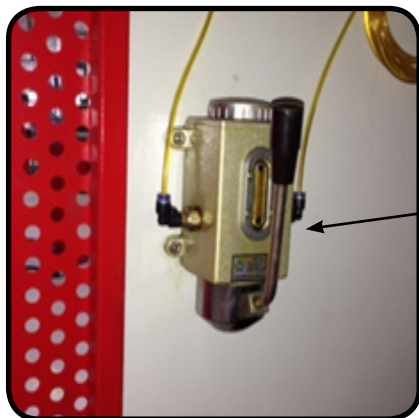

One Shot Lubrication (8hrs)

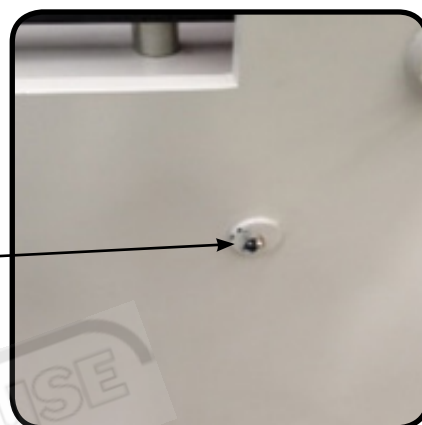

2 x Grease Points (8hrs)



3 x Grease Points (8hrs)

Lubricants.

- Cylinder and main pivot points - grease.
- Back-stop: shafts, screws, nuts - grease.
- Clamp beam slides - grease.
- Hydraulic oil #46.



2 x Grease Points (8hrs)



OPERATION MANUAL

6.3 CHANGING THE HYDRAULIC OIL

All precautions must be taken to keep the hydraulic system clean at all times. When changing oil, make sure that the top of the oil tank is clean and free from dust and dirt.

- Remove the screws from the oil tank cover and remove the cover (Fig 6.2)
- Using an appropriate pump, drain out the old oil completely. Be sure nothing is left
- Using a pump or proper equipment, add the new oil into the tank
- Oil level must be filled to the top mark of the oil indicator.
- Always keep the oil at the same level.
- Oil must be changed after first 200 working hours of use, and then after every 1000 working hours. (See: Lubrication Diagram Fig. 6.1).

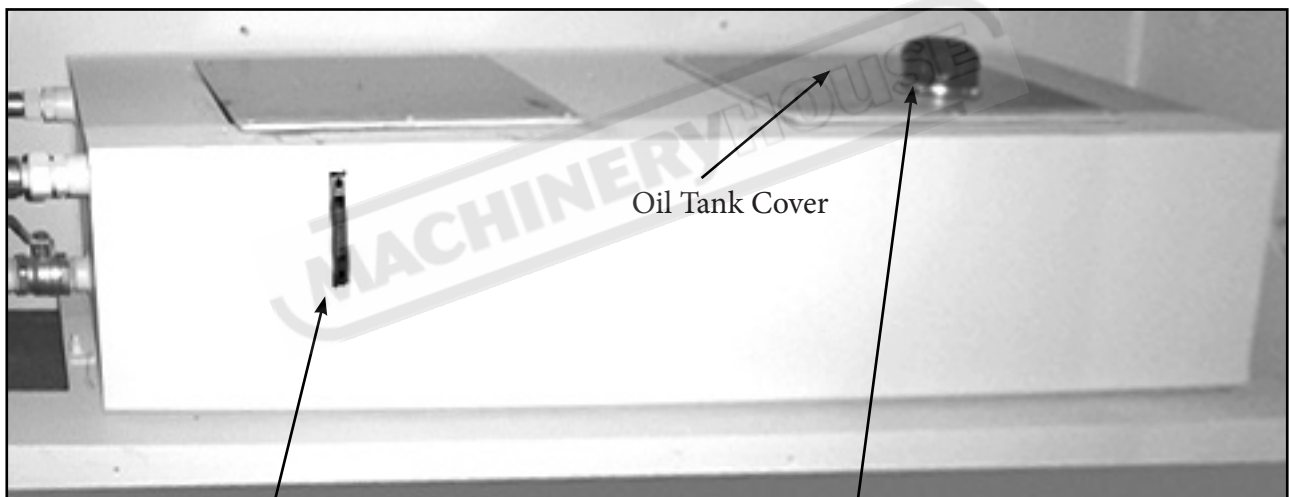
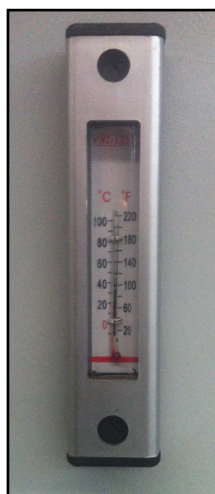

Fig. 6.2



Sight Glass



Filler Cap

6.4 CHANGING THE FILTER

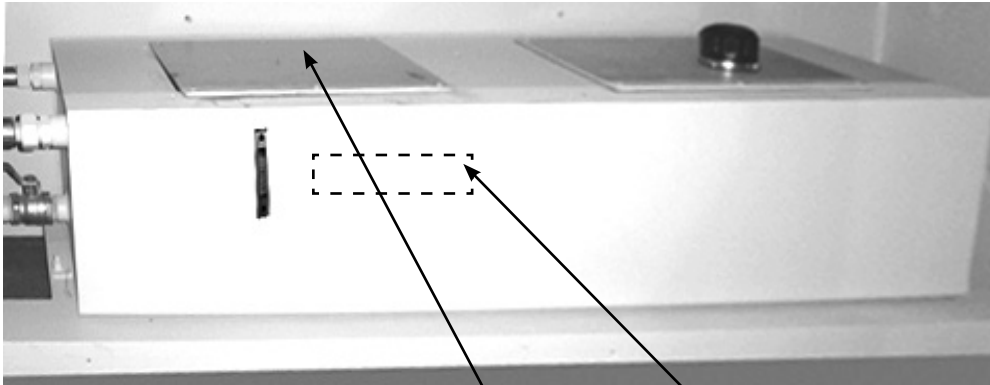

Fig. 5.6

Cover



- Remove the cover on the oil tank after loosening and removing the screws. (Fig.5.6)
- Remove the old filter from its place inside oil tank by turning in a clockwise direction
- Fit the new filter into its place by turning in a counter clockwise direction

Note ! The suction filter element must be cleaned after the first 200 hours of use, and then after every 1000 working hours. Replace if damaged or unserviceable.

6.5 ADJUSTING THE TOP BEAM SLIDES

Before the guillotine blades are adjusted for their cutting clearance. It is important that the slides to the top beam are set up.

- ❑ If the clearance is not between 0.06 ~ 0.10 mm then clearance must be adjusted by the following steps.
- ❑ With the upper beam stopped in the top position, loosen the locknuts (Fig 6.5). Tighten the plate bolt until the plate at the right hand side of the slide is about to lock then back off the bolts about 1/8th of a turn.
- ❑ Use feeler gauges, to test the clearance.
- ❑ According to the test results adjust the clearance and tighten the bolts.

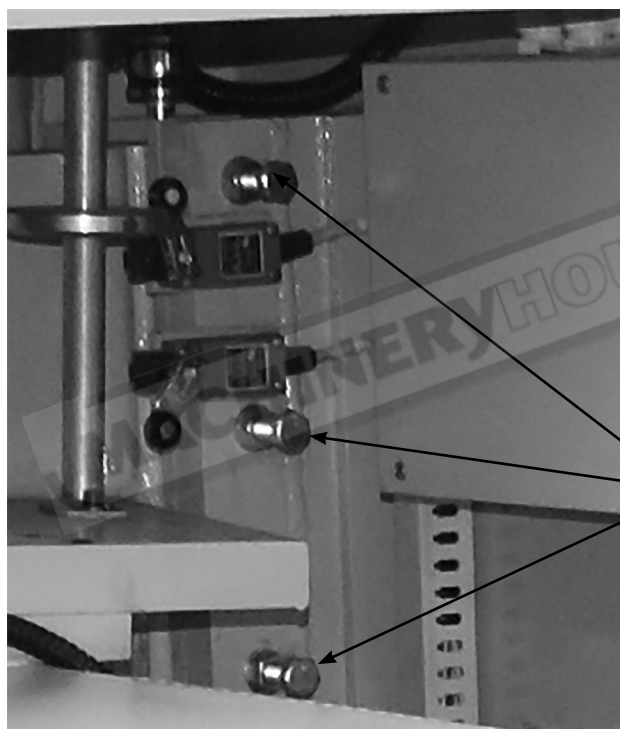

Fig 6.5

Bolts and Locknuts

6.6 ADJUSTING BLADE CLEARANCE & PARALLELISM.

The following information also applies when fitting new or sharpened blades.

- ❑ To check the clearance, set the selector control on the control box to “INCH” depress the foot pedal at short intervals (INCHING) until the blades on the right hand side are about to pass. If! there is no danger of the blades clashing, continue “inching” the machine. The blades downward travel will automatically halt at the end of the full machine stroke. (Due to the selector switch being set at “INCH”). The upper blade will return to the up position by switching the selector switch to “AUTO”.



OPERATION MANUAL

Lower Blade Parallel Adjustment.

- ❑ Loosen the lock bolts (5), and set the Rapid Blade Adjustment Dial to the maximum clearance for your machine. This is a two man job where one will need to check the blade clearance with a feeler gauge from the rear of the machine while the other adjusts the blade holder setting.
- ❑ The clearance is checked across the full length of the blades by inching the upper blade down as described in section 5.2
- ❑ When the correct gap has been achieved on each end, reset the clearance as recommended on each individual adjuster to the correct setting. Recheck the clearance after tightening. Retighten all the adjusting bolts and set the Rapid Blade Adjuster to the correct clearance for the material to be cut.

NOTE ! THE BLADE CLEARANCE STATED IS FOR GENERAL PURPOSE WORK. SHOULD LARGE QUANTITIES OF THINNER GAUGE MATERIAL BE USED, A FINER AND MORE ACCURATE TOLERANCE WOULD BE REQUIRED.

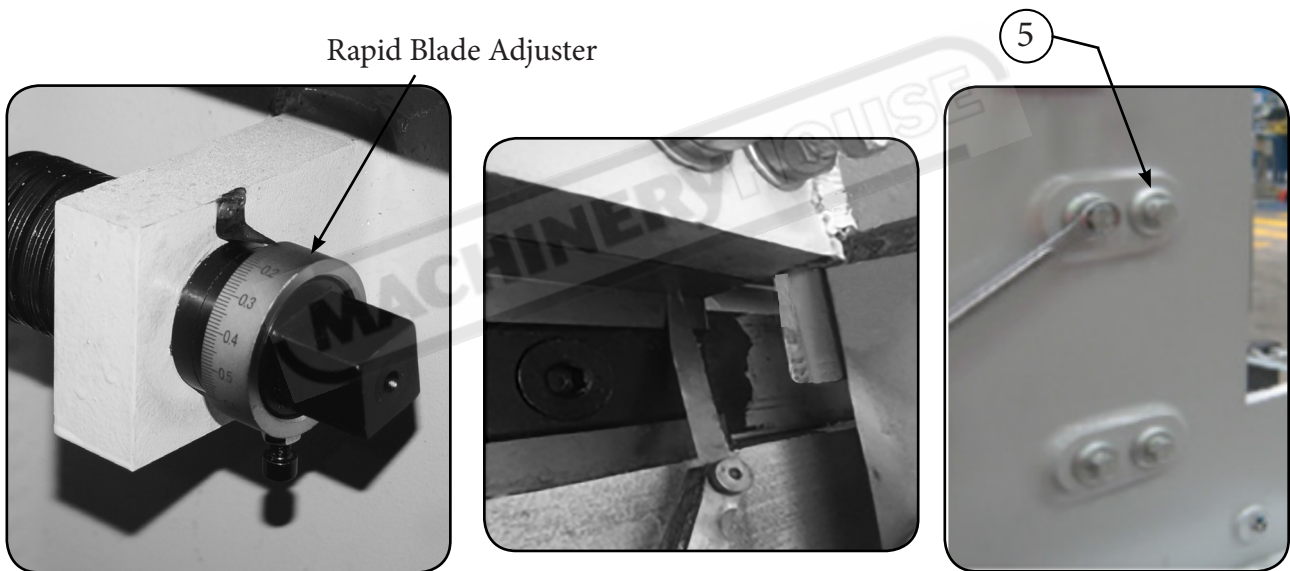

On completion of the blade setting, reset the electrical system and then press the foot pedal and allow the machine to continually cycle for two minutes. Test the cutting at maximum rated capacity. Check the hydraulic system for oil leaks. Replace and secure all covers on completion of the blade setting.

Place the sheet steel to be cut under the clamp bar and between the shearing blades. Square to the squaring stop or push the material against the backstop, or the front stop depending on which stop is being used.

Press the foot pedal to operate the shear action of the upper beam.

Check the cut to ensure the blade setting is correct



OPERATION MANUAL

5.7 TROUBLESHOOTING

PROBLEM	POSSIBLE CAUSES	ACTION
Machine shudder on the down stroke.	<ul style="list-style-type: none"> • Incorrect relief valve setting 	<ul style="list-style-type: none"> • Re-adjust relief valve Adjust the relief valve by unlocking the hexagon head grub screw on the side of the body of the valve. Turn in a clockwise direction closing the valve while cycling the machine.
Machine will not cut.	Check the blades for excessive clearance or damage to the cutting edges	<ul style="list-style-type: none"> • Reset or regrind as required. 1. Test the hydraulic pressure, if insufficient; lower the top cutting blade to its lowest position. Disconnect the hydraulic hoses to the cylinder and plug the hose. Test the machine by operating the foot pedal and inch up. If pressure is obtained in both directions, replace the hydraulic cylinder. 2. If pressure is not obtained in either direction, plug the pump delivery and recheck. If no pressure is obtained, repair or replace both the pump and the relief valve. 3. When pressure is obtained in one direction only. Remove the main ram cylinder and check for leaks by operating on a test bench. If the cylinder is not leaking, replace the directional control valve.
Machine will not stop in the neutral position.	<ul style="list-style-type: none"> • Check limit switch /relay • Check directional control valve 	<ul style="list-style-type: none"> • Replace if necessary. • Remove valve, check replace if necessary
Oil leaking from cylinder	<ul style="list-style-type: none"> • Gland seal is damaged 	<ul style="list-style-type: none"> • Change seal
Oil leaking from fittings	<ul style="list-style-type: none"> • Fittings are loose 	<ul style="list-style-type: none"> • Tighten fittings



OPERATION MANUAL

6.8 STORAGE, & RE-UTILIZATION:

In cases where the machine is not to be used for a long period of time, the following precautions must be taken:

Disconnect electrical supply to the machine, and place a “Power has been disconnected” tag on the electric panel as a reminder for future use.

The storage place of the machine must be indoor with protection against humidity, dust, and danger of fire.

Lubricate top and bottom working surfaces with an anti-rust lubricant.

Empty the oil from the tank.

Lubricate pistons and all metal surfaces with an anti-rust lubricant

Lubricate plastic hoses against cracking.

Cover the machine with a nylon cover for protection against dust.

6.2. Re-utilization after storage

Take the following steps if the machine is to be re-utilized after a long period of storage:

To use the old machine oil, make sure that the physical and chemical properties of the liquid are intact. This should be verified by an expert body. Otherwise, fill the tank with new oil.

All electrical components must be checked by a qualified electrician to make sure that all of them are properly functional. Replace the faulty components.

The machine body and mechanical parts must be checked through by authorized or qualified personnel, and the machine must be prepared for operation according to the operating instructions.



OPERATION MANUAL

B. NC89 ELECTRIC CIRCUIT DIAGRAM

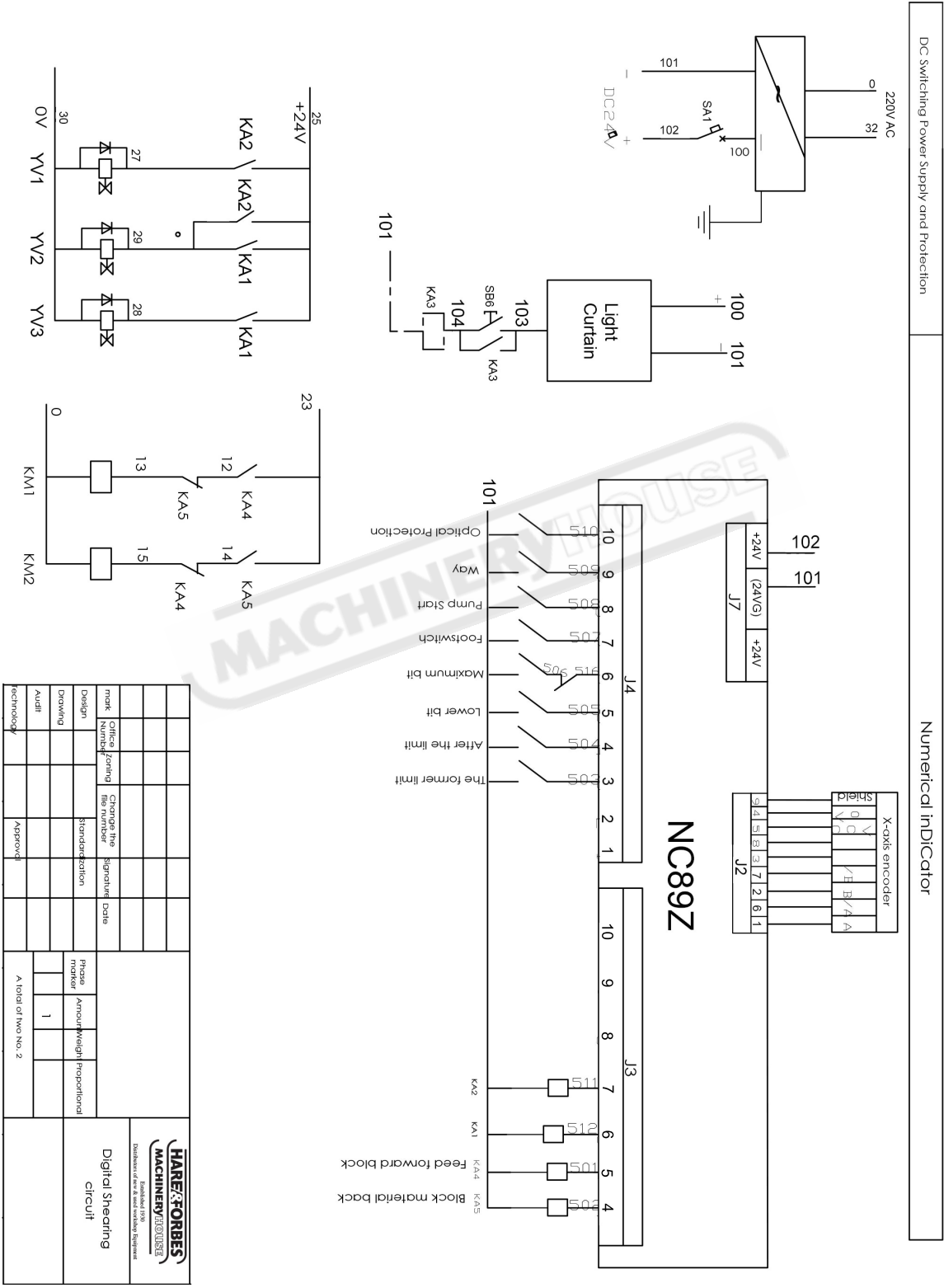

Design	Office zoning	Change the file number	Signature	Date	Phase marker Amount/weight proportional A total of two No. 2	 Distribution of Australia and New Zealand Digital Shearing circuit
Drawing	Design	Standardization				
Approval						
Technology						



OPERATION MANUAL

C. ELECTRIC CIRCUIT DIAGRAM

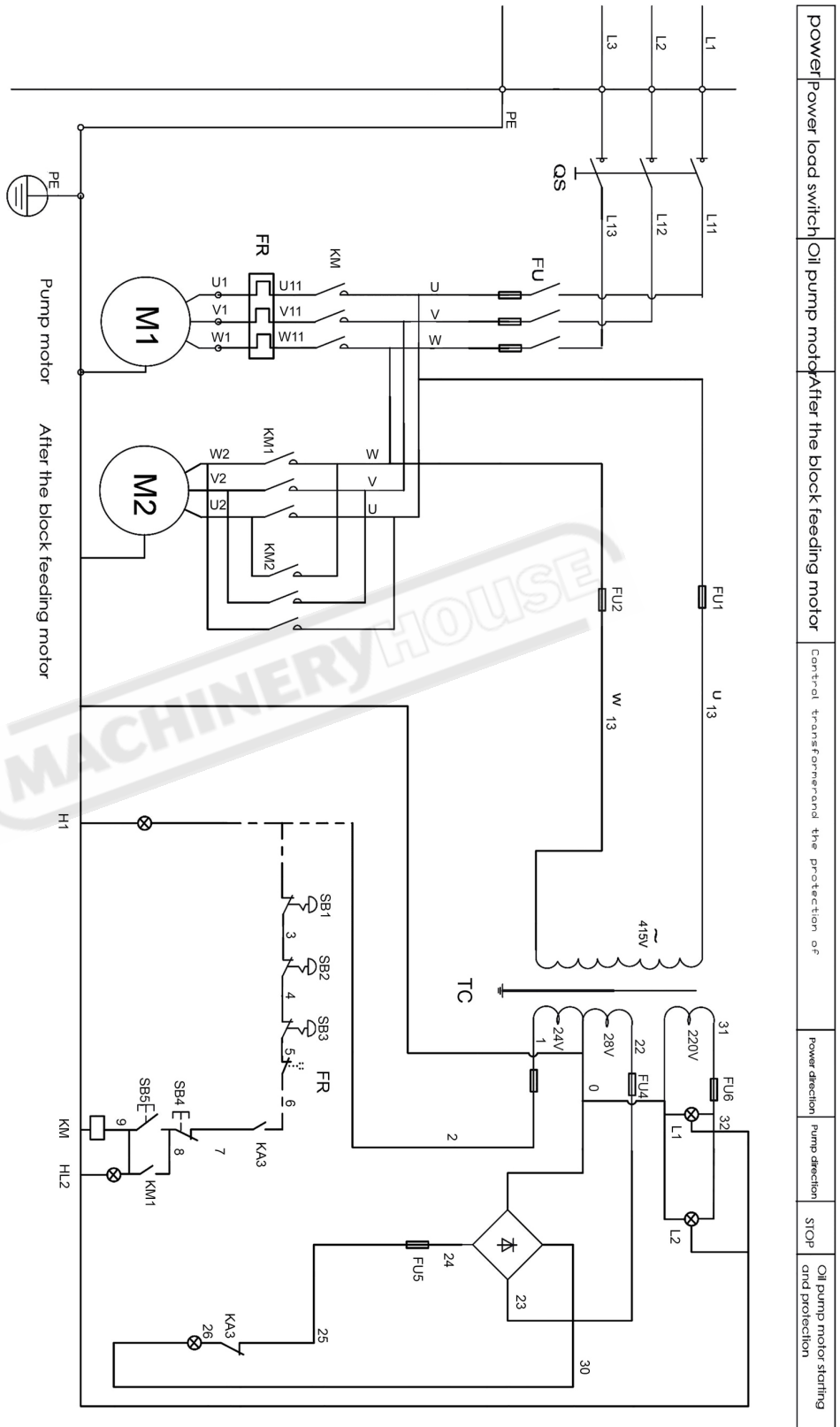

Oil pump motors, circuit breakers and contactors variable parameter list

Electrical Code	Model	Motor Model	Power	Current	Speed	Breaker Model (GFI)	Contactor Type (KM1)
M1		Y132M-4	7.5KW	15.4A	1440r/min	EV2-ME20C	CI-D1810N
		Y160M-4	11KW	22.5A	1460r/min	EV2-ME32C	CI-D2510N

mark	Checked	Drawing	Audit	Technology	Approval	Change the Signature		Date	Phase marker	Amount	Weight	Proportional	Digital Shearing circuit
						Signature	Signature						
A total of two No. 1													

Wuxi City, China del Automation Control Technology Co., Ltd.



WARNING

General Machinery Safety Instructions

Machinery House
requires you to read this entire Manual before using this machine.

- 1. Read the entire Manual before starting machinery.** Machinery may cause serious injury if not correctly used.
- 2. Always use correct hearing protection when operating machinery.** Machinery noise may cause permanent hearing damage.
- 3. Machinery must never be used when tired, or under the influence of drugs or alcohol.** When running machinery you must be alert at all times.
- 4. Wear correct Clothing.** At all times remove all loose clothing, necklaces, rings, jewelry, etc. Long hair must be contained in a hair net. Non-slip protective footwear must be worn.
- 5. Always wear correct respirators around fumes or dust when operating machinery.** Machinery fumes & dust can cause serious respiratory illness. Dust extractors must be used where applicable.
- 6. Always wear correct safety glasses.** When machining you must use the correct eye protection to prevent injuring your eyes.
- 7. Keep work clean and make sure you have good lighting.** Cluttered and dark shadows may cause accidents.
- 8. Personnel must be properly trained or well supervised when operating machinery.** Make sure you have clear and safe understanding of the machine you are operating.
- 9. Keep children and visitors away.** Make sure children and visitors are at a safe distance for you work area.
- 10. Keep your workshop childproof.** Use padlocks, Turn off master power switches and remove start switch keys.
- 11. Never leave machine unattended.** Turn power off and wait till machine has come to a complete stop before leaving the machine unattended.
- 12. Make a safe working environment.** Do not use machine in a damp, wet area, or where flammable or noxious fumes may exist.
- 13. Disconnect main power before service machine.** Make sure power switch is in the off position before re-connecting.
- 14. Use correct amperage extension cords.** Undersized extension cords overheat and lose power. Replace extension cords if they become damaged.
- 15. Keep machine well maintained.** Keep blades sharp and clean for best and safest performance. Follow instructions when lubricating and changing accessories.
- 16. Keep machine well guarded.** Make sure guards on machine are in place and are all working correctly.
- 17. Do not overreach.** Keep proper footing and balance at all times.
- 18. Secure workpiece.** Use clamps or a vice to hold the workpiece where practical. Keeping the workpiece secure will free up your hand to operate the machine and will protect hand from injury.
- 19. Check machine over before operating.** Check machine for damaged parts, loose bolts, Keys and wrenches left on machine and any other conditions that may effect the machines operation. Repair and replace damaged parts.
- 20. Use recommended accessories.** Refer to instruction manual or ask correct service officer when using accessories. The use of improper accessories may cause the risk of injury.
- 21. Do not force machinery.** Work at the speed and capacity at which the machine or accessory was designed.
- 22. Use correct lifting practice.** Always use the correct lifting methods when using machinery. Incorrect lifting methods can cause serious injury.
- 23. Lock mobile bases.** Make sure any mobile bases are locked before using machine.
- 24. Allergic reactions.** Certain metal shavings and cutting fluids may cause an allergic reaction in people and animals, especially when cutting as the fumes can be inhaled. Make sure you know what type of metal and cutting fluid you will be exposed to and how to avoid contamination.
- 25. Call for help.** If at any time you experience difficulties, stop the machine and call you nearest branch service department for help.

WARNING

Power Operated Guillotine Safety Instructions

Machinery House
requires you to read this entire Manual before using this machine.

- 1. Maintenance.** Make sure the Guillotine is turned off and disconnect from the main power supply and make sure all moving parts have come to a complete stop before any inspection, adjustment or maintenance is carried out.
- 2. Guillotine Condition.** Guillotine must be maintained for a proper working condition. Never operate a Guillotine that has low oil levels, damaged or worn parts. Scheduled routine maintenance should be performed on a scheduled basis.
- 3. Blade Condition.** Never operate a Guillotine with a damaged or badly worn blades. Replace if required.
- 4. Pump Direction.** Pump rotation must be in arrow direction otherwise the pump will be damaged.
- 5. Hand Hazard.** Keep hands and fingers clear from moving parts. Serious injury can occur if hand or finger tips come between blades.
- 6. Personal Protection.** Gloves are recommended when handling the workpieces.
- 7. Authorized and trained personnel.** The machine must be operated by authorized and trained personnel. The shear is designed to be operated by a single user. Using the machine with more than one operator is forbidden, except for certain maintenance situations.
- 8. Power outage.** In the event of a power failure during use of the machine, turn off all switches to avoid possible sudden start up once power is restored.
- 9. Work area hazards.** Keep the area around the Guillotine clean from oil, tools, objects & chips. Pay attention to other persons in the area and know what is going on around the area to ensure unintended accidents.
- 10. Guards.** Operate machine only with all protective devices and guarding in place and operational. Never remove, defeat or bypass. Any presence-sensing safeguarding used must have regular Safety integrity tests and records kept. These records must be kept for 5 years or for the life of the plant and be handed to any person that you relinquish control of the plant to. Tests include stop time measurements, safety distance calculations and inspections, with operator checks and periodic maintenance checks. (WHS Regulation 226)
- 11. Material.** Material must NOT be hardened ceramic or glass-originated, non flat metals (at origin) e.g. rods, bars, tubes & pipes.
- 12. Blade gap adjustment.** Do NOT operate the machine without proper blade gap adjustment according to sheet thickness.
- 13. Warning Labels.** Take note of any warning labels on the machine and do not remove them.
- 14. Backgauge Area.** Do not access the backgauge area, while the machine is working.
- 15. Protective fence.** Do not bridge the safety limit switch of the rear protective fence.
- 16. Squaring arm.** Do not use side squaring arm and front support arms for intermediate storage of workpieces.
- 17. Operation.** During the shearing process, the workpiece may slide or move unexpectedly. Therefore, the material must be handled carefully.
- 18. Emergency stop.** Use the emergency stop button in case of any emergency.
- 19. Level machine.** Level the machine on a flat concrete surface by using a spirit level.
- 20. Overloading machine.** Do not exceed the rated capacity of the guillotine. Please refer to the manual for capacities.
- 21. Hearing protection and hazards.** Always wear hearing protection as noise generated from machine and workpiece can cause permanent hearing loss over time.
- 22. Call for help.** If at any time you experience difficulties, stop the machine and call your nearest branch service department for help.

PLANT SAFETY PROGRAM

NEW MACHINERY HAZARD IDENTIFICATION, ASSESSMENT & CONTROL

Power Operated Guillotine

Developed in Co-operation Between A.W.I.S.A and Australia Chamber of Manufactures
This program is based upon the Safe Work Australia, Code of Practice - Managing Risks of Plant in the Workplace (WHSA 2011 No10)

Item No.	Hazard Identification	Hazard Assessment	Risk Control Strategies <small>(Recommended for Purchase / Buyer / User)</small>
B	CRUSHING	LOW	Secure & support work material on table.
C	CUTTING, STABBING, PUNCTURING	MEDIUM	Wear gloves to prevent cuts from sharp material offcuts.
D	SHEARING	MEDIUM	Hands should be kept clear of moving parts and blades. Isolate power to machine prior to any checks or maintenance. Ensure front blade guard is fitted securely. Do not adjust or clean until machine has fully stopped. Access to the rear of machine must be interlock or photoelectric guarded to prevent access when the machine is operating, (see workover authority principles of machine guarding for guidelines).
F	STRIKING	MEDIUM	Wear safety glasses. Stand clear of falling offcuts. Ensure material hold downs are correctly adjusted. Ensure guards are secured properly.
H	ELECTRICAL	MEDIUM	Machine should be installed & checked by a Licensed Electrician. All electrical enclosures should only be opened with a tool that is not to be kept with the machine.
O	OTHER HAZARDS, NOISE.	LOW	Wear hearing protection as required.
Plant Safety Program to be read in conjunction with manufactures instructions			



www.machineryhouse.com.au



www.machineryhouse.co.nz

Authorised and signed by:

Safety officer:

Manager:

Revised Date: 25th Sept 2015